



Warm

Design by Ramos & Bassols

VIBIA
LIGHT IS CREATION





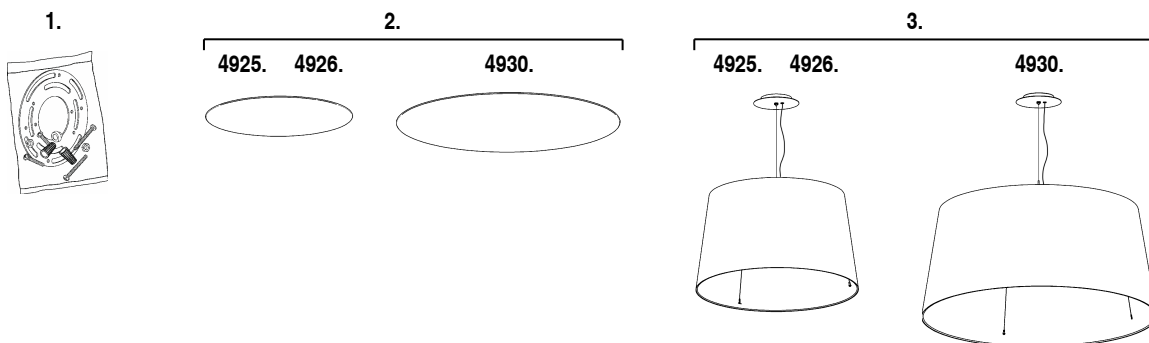

ASSEMBLY INSTRUCTIONS

SUPPLIED MATERIAL



	4925-INC	4926-INC	4930-INC
1 Instalation components bag	1 un.	1 un.	1 un.
2 Diffuser	1 un.	1 un.	1 un.
3 Lamp structure	1 un.	1 un.	1 un.

TECHNICAL SPECIFICATIONS

4925	Net Weight	8,59 lbs		4 x E-26 Med. Base 120V 60W Max.	IP20	c  us	~ 50-60 Hz	DRY LOCATION
4926	Net Weight	11,24 lbs		4 x E-26 Med. Base 120V 60W Max.	IP20	c  us	~ 50-60 Hz	DRY LOCATION
4930	Net Weight	16,97 lbs		4 x E-26 Med. Base 120V 60W Max.	IP20	c  us	~ 50-60 Hz	DRY LOCATION

IP20 Product protected against solid object as big as or bigger than 12mm. No protection against water.

~ Alternating current

Caution

Before assembling and installing this product, carefully read the following:

- Switch of the mains before installing the lamp.
- Never use a bulb with a wattage exceeding the recommended one. Always use a bulb with the recommended wattage or lower.
- To install on the ceiling, always choose the most adequate fixing tools for the ceiling material.
- If the steel cable or the power cord of this lamp is damaged, it must be replaced only by the manufacturer or their technical service or by a person capacitated to this effect to avoid any risk.

This lamp is for indoor use only, excluding bathrooms or any type of humid surface.

ASSEMBLY INSTRUCTIONS

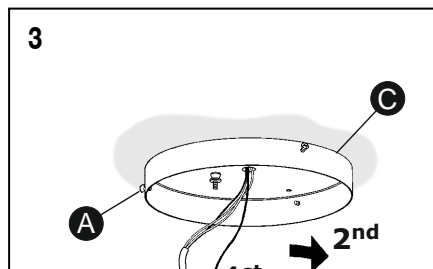
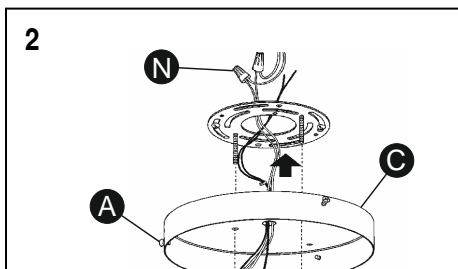
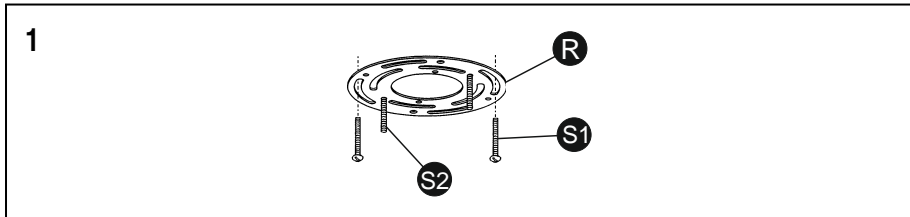

IMPORTANT NOTICE:

Caution : to avoid possible electrical shock, make certain electricity is shut off at main panel before wiring

1. Making certain that the threads of the cross bar screws are pointing away from the ceiling, secure the round cross bar (R) to the junction box using the mounting screws (S1) after inserting the screws (S2) from within out.

2. Loosen the three screws (A) to remove the base (B). Connect the white fixture wire to the white wire of the supply circuit. Connect the black fixture wire to the black wire of the supply circuit. Secure with the wire nuts (N) and tape connections with electrical tape. Connect the fixture yellow and green ground wire and the supply green tinted ground wire to the ground screw on the round cross bar using the ground terminal.

Push the connections and all excess wire to the interior of the junction box.

ASSEMBLY INSTRUCTIONS

INSTRUCCIONES DE MONTAJE

MONTAGEANLEITUNG

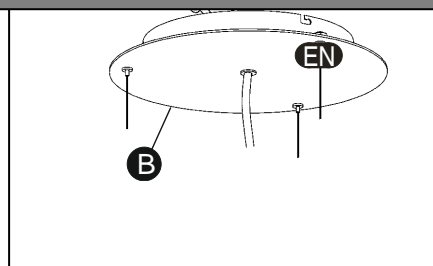
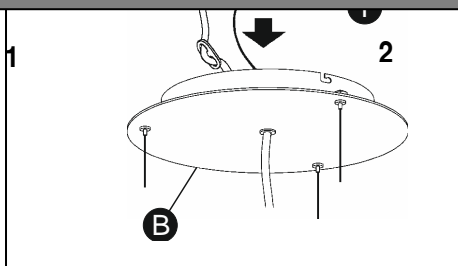

that the black wires are on one side of the junction box and the white wires on the other.

Secure the plaque (C) to the round cross bar, using the cross bar screws (S2) and the thumb nuts (T).

3. Reinstall the base (B) as shown by the arrows. Tighten the screws (A) to fix the lamp to the plaque (C).

4. After installing the bulbs, hang the lower diffuser to the cables.

5. To adjust the height of the shade use the three cable holders (D) placed on the ceiling unit (B).

Cable lengthening: The cable can be released by pushing the piston (D). Keep the piston pressed and adjust the length of the cable as desired (see Fig. X).

IMPORTANT: Hold the cable firmly to avoid the lamp from falling.

Cable shortening: There is no need to press the piston (D). Pull the cable upwards. The piston prevents the cable from moving downwards again (see Fig. Y).

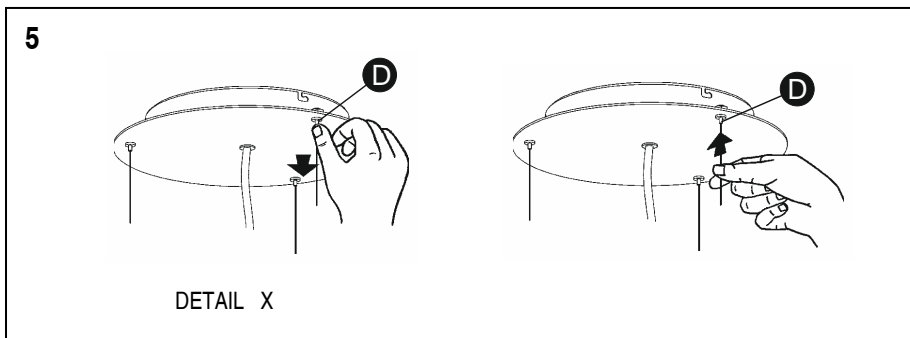
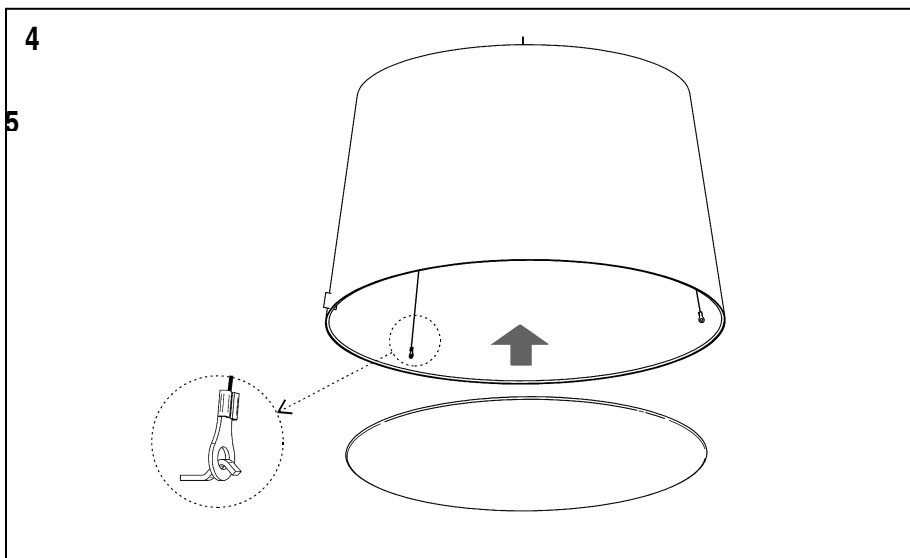

DETAIL Y

Maintenance

- Use a slightly-wet cotton cloth for cleaning.
- In case of malfunction or damage, please contact the retailer who sold the lamp.