

Artemide®

Orsa

design
Foster + Partners

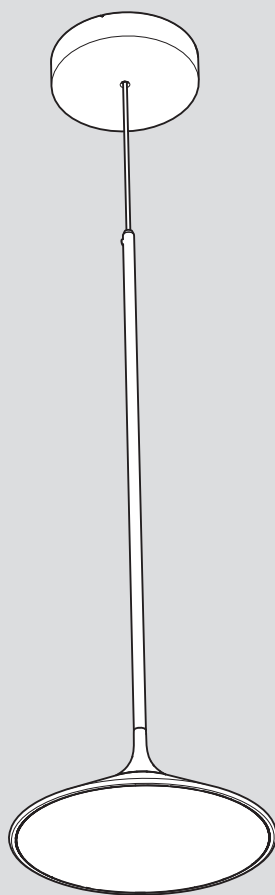

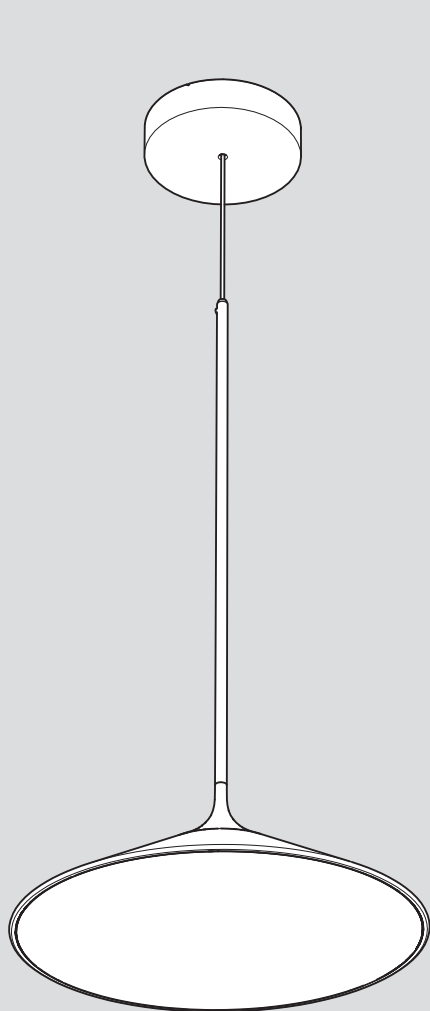

i

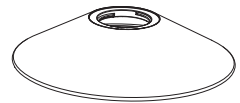
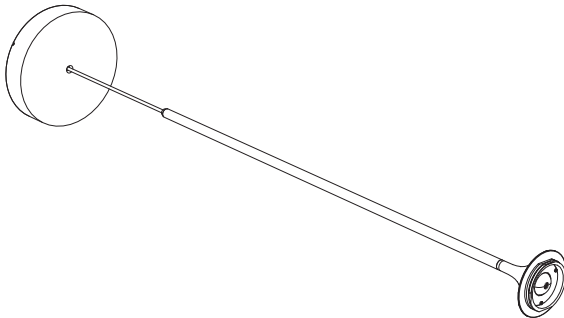
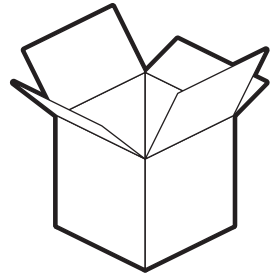
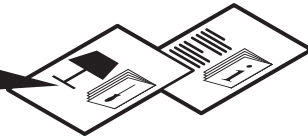

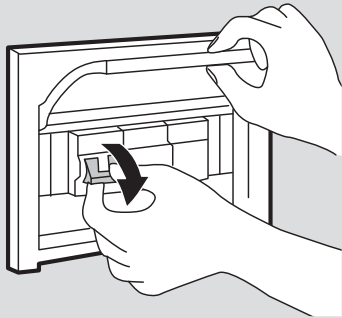

2

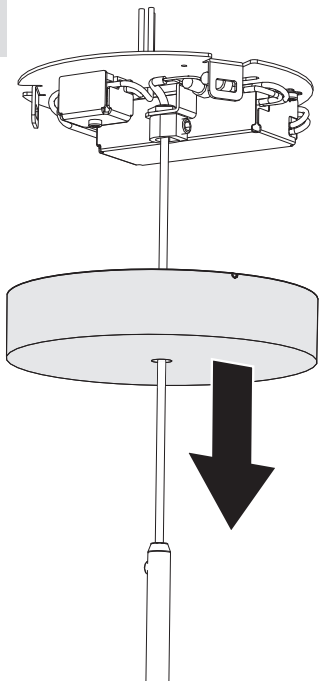

1

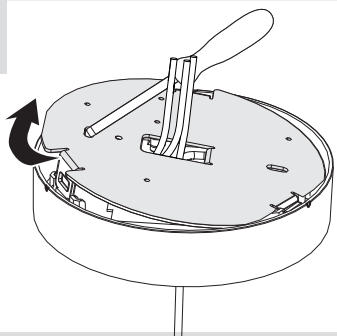

3a



120 V

Phase cut
Coupure de phase
Corte de fase

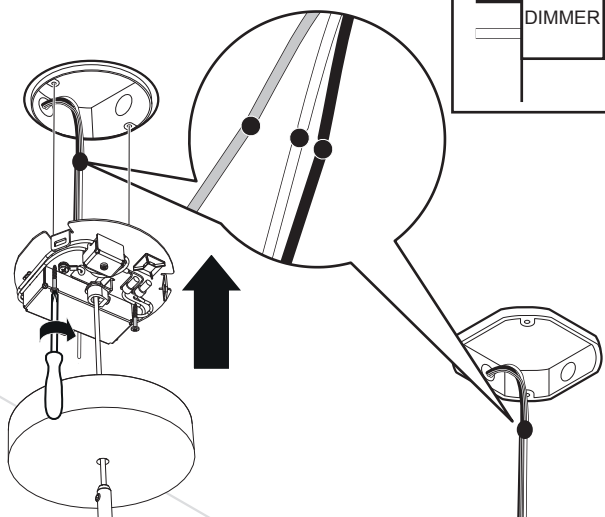
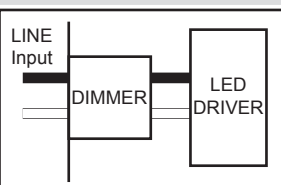

- | | | |
|--------------------|--|--------------------|
| white/blanc/blanco | | white/blanc/blanco |
| green/vert/verde | | green/vert/verde |
| black/noir/negro | | black/noir/negro |

3b



120 V

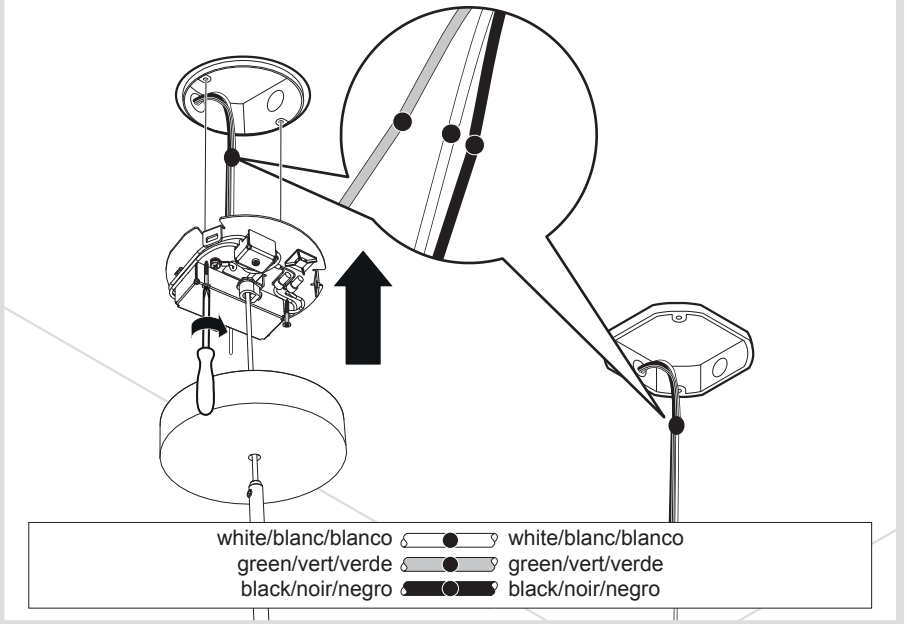

i

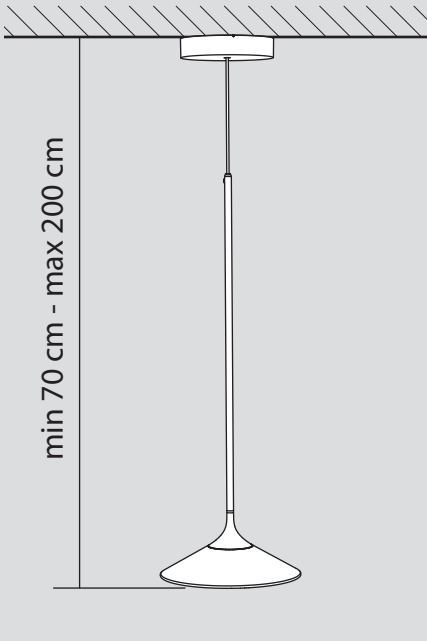

4

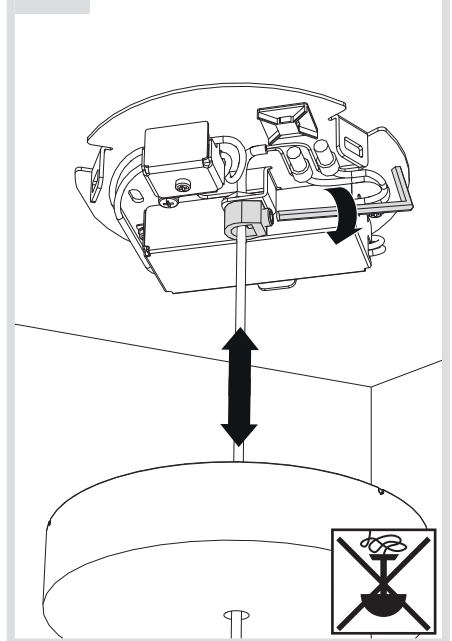

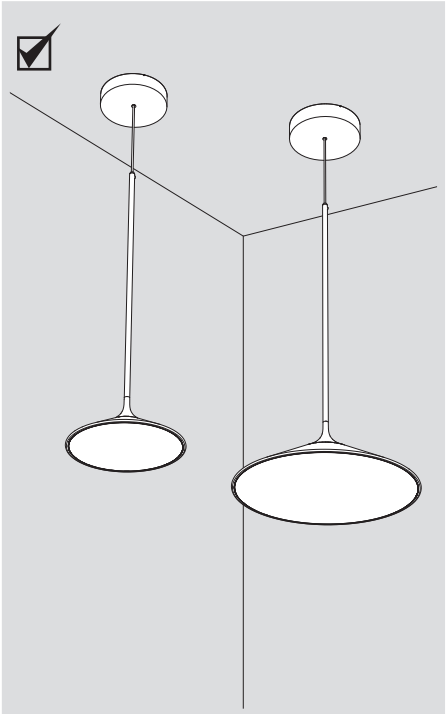
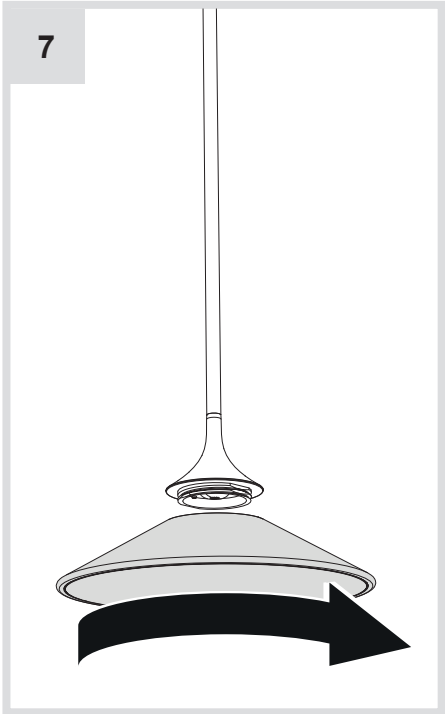
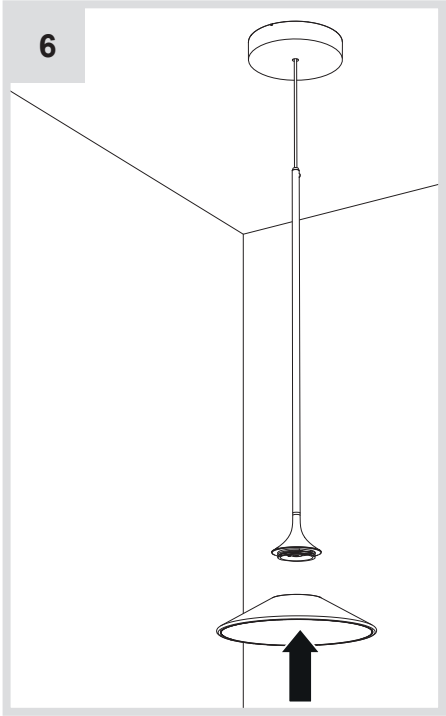
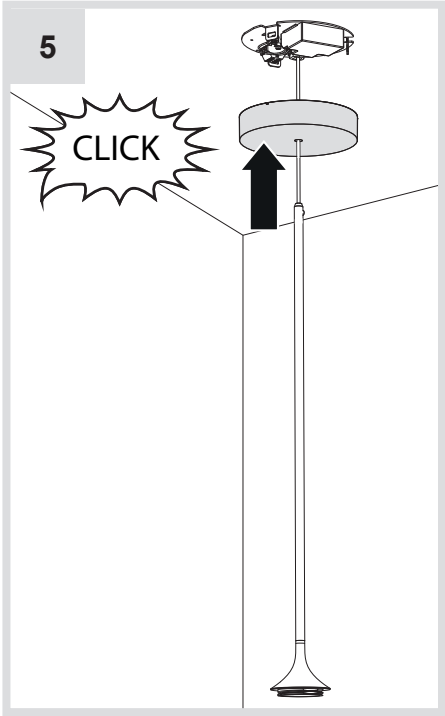

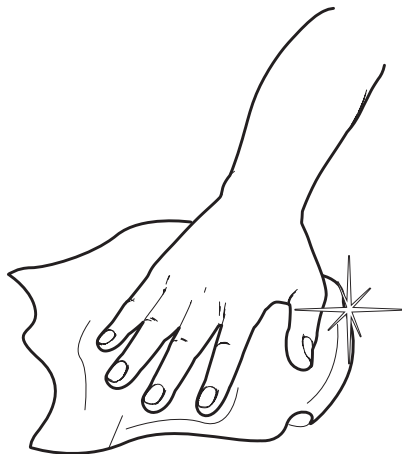

Artemide®



Artemide

via Bergamo, 18
20010 Pregnana M.se (MI)
ITALIA

tel. +39 02 935 181
fax +39 02 935 90 254
fax +39 02 935 90 496

www.artemide.com

VAT IT00846890150

Artemide Inc.

250 Karin Lane
Hicksville, NY 11801

Tel. 631 694 9292
Toll Free 1-877-Art-9111
Fax 631 694 9275

www.artemide.net

Artemide Ltée/Ltd.

11105 rue Renaude Lapointe
Montréal, Québec H1J 2T4

Tel. 514 323 6537
Toll Free 888 777 2783
Fax 514 323 8864

www.artemide.net

cod. Y513000784