

Features

- Provides On/Off operation with precise control of water volume and intensity.
- Single handle operation.
- 10.0 gpm flow rate at 45 psi.
- 1/2" female NPT connections.
- Ideal for use with Kohler thermostatic mixing valves.
- Quarter-turn operation with ceramic disc cartridge.
- Requires volume control valve trim (sold separately).

Material

- Forged dezincification-resistant brass body provides long term reliability and resistance to aggressive water conditions.



Codes/Standards

ASME A112.18.1/CSA B125.1

KOHLER® Faucet Lifetime Limited Warranty

See website for detailed warranty information.

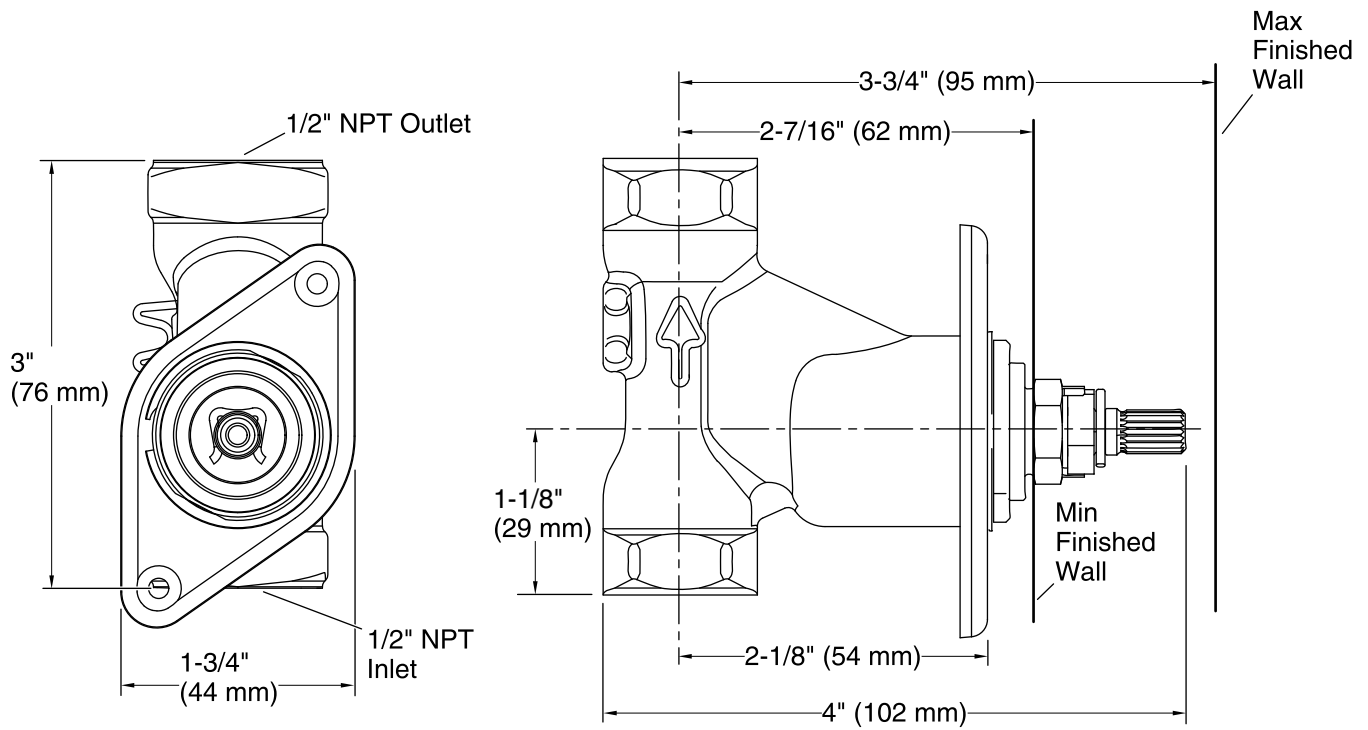

Technical Information

All product dimensions are nominal.