

**MODEL NUMBER:**

- ❑ **TU105740 Two-Handle Pressure Balance Trim Kit**  
With integrated diverter control. LESS Valve and Cartridge.
- ❑ **FLASH 2-HANDLE INTEGRATED PRESSURE BALANCE ROUGH VALVES:**

**FOR DISCRETE CAPABILITY**

**2-Way (Discrete): RU521 Flash Rough Valve Body**

- Includes 2-Way Discrete cartridge. LESS Trim. 1/2" NPT inlets/outlets.

**3-Way (Discrete): RU531 Flash Rough Valve Body**

- Includes 3-Way Discrete cartridge. LESS Trim. 1/2" NPT inlets/outlets.

**FOR SHARED CAPABILITY**

**2-Way (Shared): RU521 Flash Rough Valve Body**

- Also requires 2-Way Shared cartridge RP# M970720-0070A (sold separately)
- LESS Trim. 1/2" NPT inlets/outlets.

**3-Way (Shared): RU531 Flash Rough Valve Body**

- Also requires 3-Way Shared cartridge RP# M970730-0070A (sold separately)
- LESS Trim. 1/2" NPT inlets/outlets.

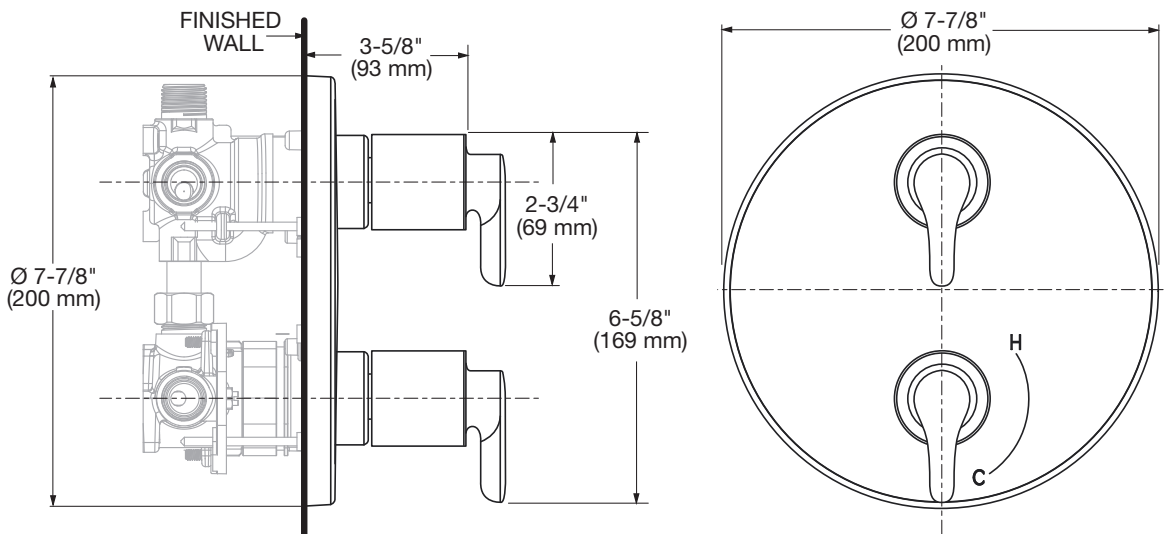

**GENERAL DESCRIPTION:**

Cast DZR brass valve body. The single unit contains two handles, the bottom lever handle turns on the water and is adjustable to the desired temperature. The top handle functions as the diverter, allowing water to flow from specific outlets. The volume is controlled by twin ceramic disc valve cartridges. The Flash valve includes a Hot Limit Safety Stop. Available with 1/2" NPT inlets and outlets. The valve has a high flow rate, ideal for multiple outlet installations.

**PRODUCT FEATURES:**

- DZR Brass Casting:** Highest quality faucet material for durability and long life.
- Back to Back Capable:** Hot and cold can be reversed.
- Spring-Loaded Check Valves:** When the hot and cold water enters the fitting, both supplies pass through the spring-loaded check valves to prevent cross flow of hot and cold water.
- Integrated Stop Valves:** Ensure easy cleaning and servicing.
- Adjustable Hot Limit Safety Stop:** Limits the amount of hot water allowed to mix with cold. Reduces the risk of accidental scalding.



BARRIER FREE | ADA COMPLIANT

**SUGGESTED SPECIFICATION**



Two-handle pressure balance rough valve shall feature a cast DZR brass valve body. Shall also feature ceramic disc valving, 1/2" NPT inlets and outlets. Fitting shall be American Standard Model # TU105740.xxx (Trim Kit) and RU521 (2-Way) or RU531 (3-Way) Rough Valve.

**CODES AND STANDARDS**

These products meet or exceed the following codes and standards:

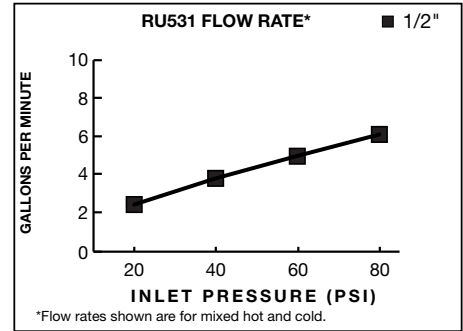
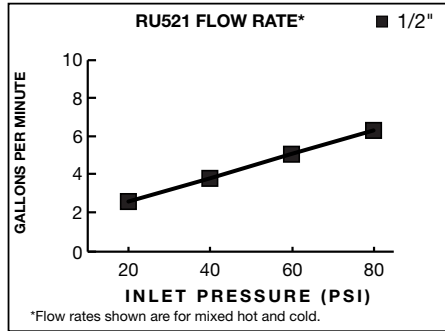
- ASSE 1016
- ASME A112.18.1
- CSA B125.1



<b>TRIM KITS **</b>		<b>** TRIM &amp; ROUGH MUST BE ORDERED SEPARATELY.</b>	<b>Finish Options</b>		
	<b>Product Number</b>	<b>Description</b>	Polished Chrome	Brushed Nickel	Matte Black
	TU105740	Flash™ 2-Handle Integrated Diverter Pressure Balance Valve Trim.  	002	295	243

<b>ROUGH VALVE BODIES</b>	<b>Product Number</b>	<b>Description</b>
	RU521	2-Way Rough Valve Body. 1/2" NPT Inlets/Outlets. With separate diverter control only. LESS trim. NOTE: 2-Way Discrete Cartridge ships with valve. 2-Way Shared Flow functionality requires purchase of 2-Way Shared Cartridge #M970720-0070A (sold separately)
	RU531	3-Way Rough Valve Body. 1/2" NPT Inlets/Outlets. With separate diverter control only. LESS trim. NOTE: 3-Way Discrete Cartridge ships with valve. 3-Way Shared Flow functionality requires purchase of 3-Way Shared Cartridge #M970730-0070A (sold separately)

 Meets CSA B651 Barrier Free code. Check local codes.

 Meets the American Disabilities Act Guidelines and **ANSI A117.1** Requirements for the physically challenged.