



Type P (pressure balance) rough without cartridge
PEX
R51-SPEX



Specifications

Descriptions

- 1/2" inlet PEX
- Service valves
- 1/2" shower outlet PEX
- 3/4" bath outlet PEX or 1/2" sweat
- Test cap
- TXX51XX trim required to complete
- Rough only

Available colors

- :

Certifications

- CSA B125.1
- ASME A112.18.1
- ASSE 1016
- CMR248 Approval

UPC®

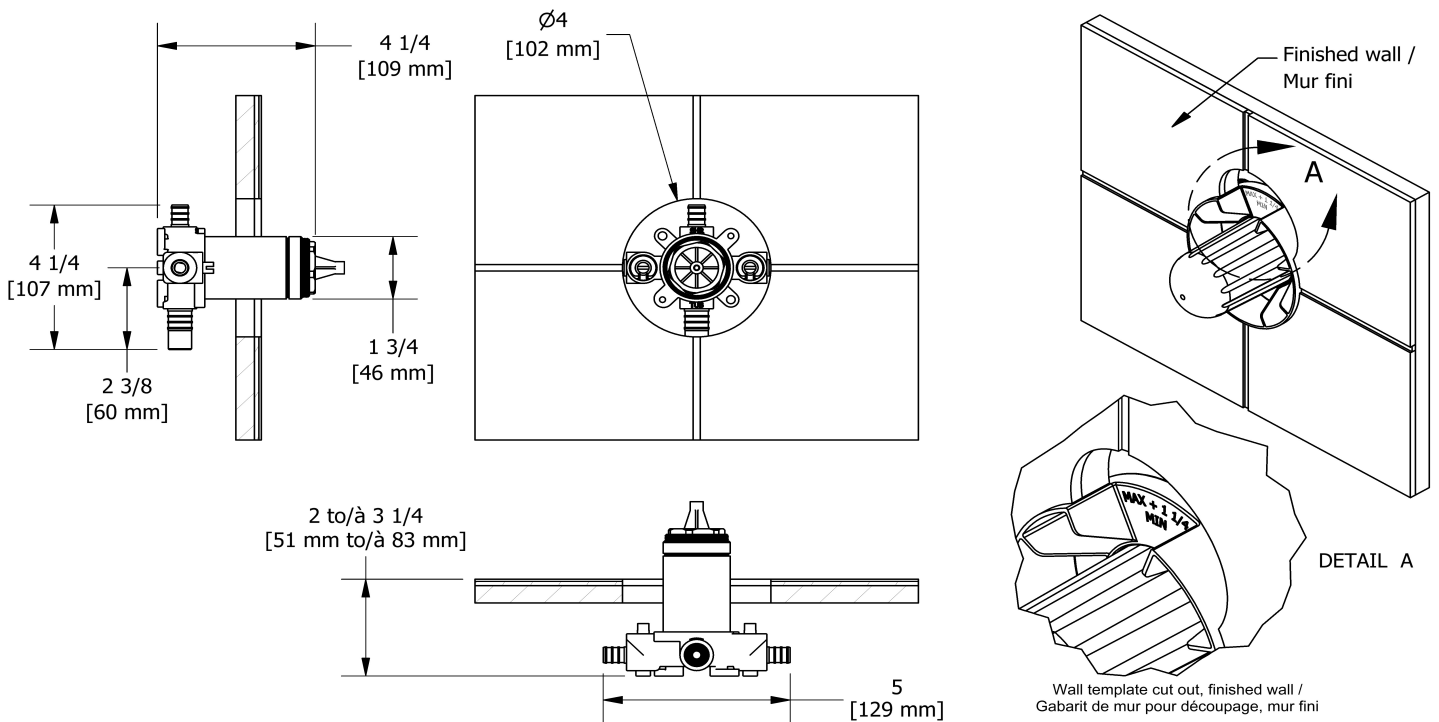

Sizes, models and finishes may differ from those presented.

Warranty

This **Riobel Inc.** product you have purchased carries a Limited Lifetime Warranty on the chrome, PVD finish, blacks and all working parts and is guaranteed from the initial purchase date against all manufacturing defects. All other finishes, including plastic components, are guaranteed for one year. All electric and/or electronic parts are covered by a 5-year limited warranty.

Customer Service

Ontario, West Canada : 888-287-5354 Quebec, Maritimes, United States : 866-473-8442

2020.06.25