

LED Exterior Wall Sconce

EW7918
INSTALLATION SHEET

START FROM HERE

- Make sure **POWER** is **COMPLETELY OFF** at the fuse box
- Have your fixture installed by a qualified licensed electrician
- Prepare everything in a clear area
- Wear gloves at all time during this installation
- Read instructions carefully before you start assembly
- Keep this installation sheet for future reference

Technical Support: 1-855-855-8926

Please Note:

- All Kuzco LED fixtures come with pre-wired LED module(s).
- Unless instructed to do so, please do not touch any part of the LED module(s) as any unnecessary contact with the module could cause permanent damage.
- For dimming, an ELV (Electronic Low Voltage) type of dimmer is required.

- 1.** Remove the fixture from its original packaging. Remove the mounting plate (**1c**) from within the canopy backplate (**2b**) by loosening the two set screws (**2a**). Attach the mounting plate (**1c**) to the electrical junction box (**1a**), using the two screws (**1d**) provided in the hardware package.
- 2.** Attach the canopy (**2b**) to the mounting plate (**1c**), which is attached to the electrical junction box (**1a**) on the wall. First attach all wiring with the provided marettes (**1b**) (white to white "N", black to black "L", ground to ground "G"). Now push the canopy (**2b**) onto the mounting plate (**1c**) and secure with the two set screws (**2a**) using the allen key provided.
- 3.** To prevent moisture from entering the outlet box and causing a short, seal around the top and side perimeter between the fixture and the wall surface with weather resistant caulking (**see illustration 1**). The space at bottom should be left un-caulked to prevent moisture build-up.
- 3.** You have now completed the installation of your fixture, enjoy.

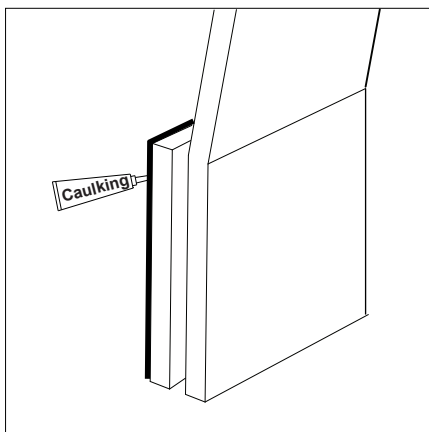
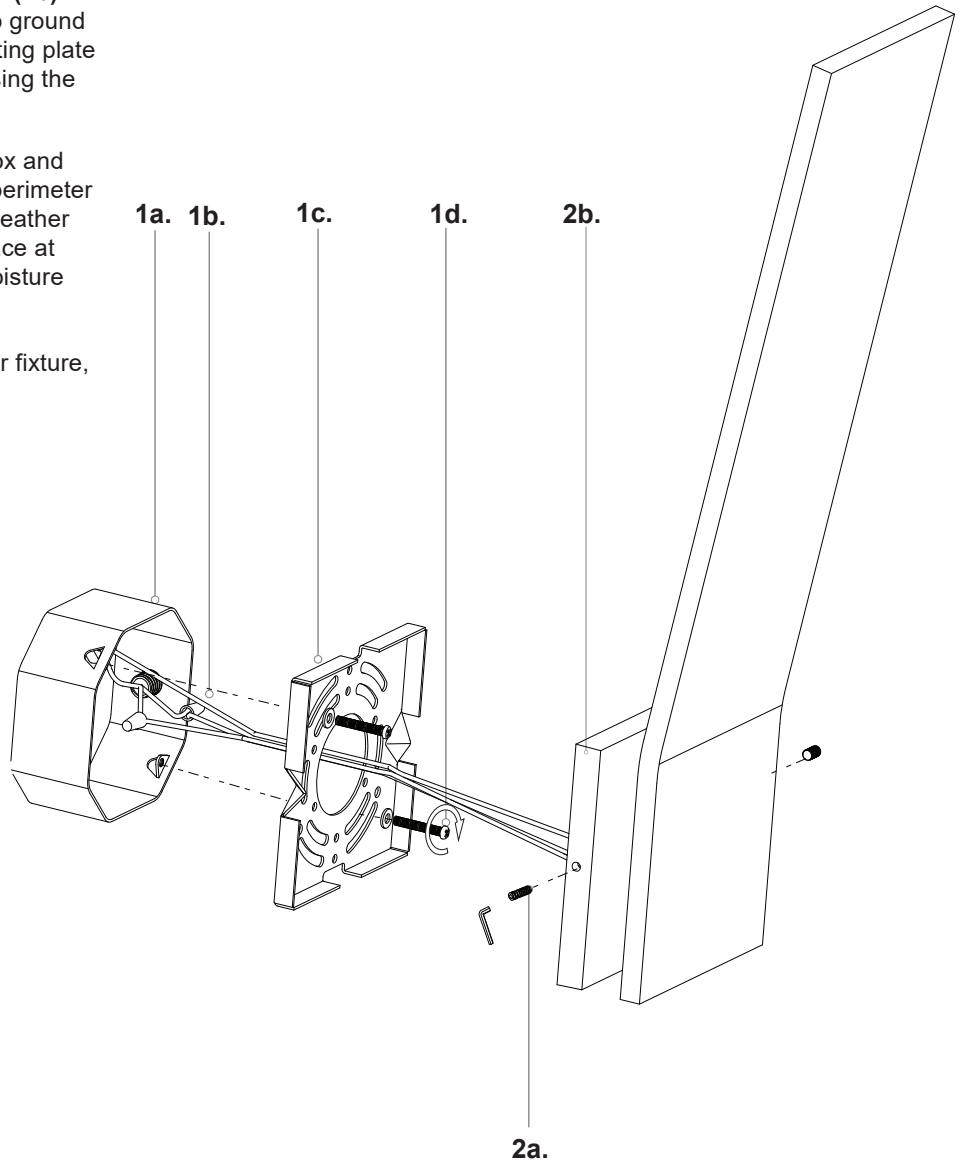

Illustration 1.



KUZCO

19054 28th Avenue Surrey, BC Canada V3Z 6M3
T: 604 538 7162 TF: 1-855 85 KUZCO F: 604 538 7196
W: kuzcolighting.com
20181127